

Sink Phantom Base Copper

Recommended for 12mm thickness

Kitchen Sinks

Code: 5554 048

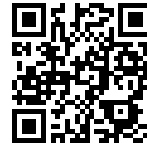

DETAILS

Coloring	Copper
Finish	PVD
Material	AISI 304 stainless steel
Texture	Brushed in line
Dimensions	430x430 mm for 12 mm thick sheets
Standard fittings	Drain, Foster overflow and universal corrugated pipe (for installing different overflows), Boxed packing
Built-in hole	View technical data sheet
Bowl dimension	400x400mm
Number of bowls	1 bowl

Waste fitting

3,5" drain

FEATURES

Copper

The Copper finish is obtained by treating steel with a physical process called PVD (Physical Vacuum Deposition) which deposits particles of noble metals on the surface. The result is a unique and refined aesthetic effect, and an improvement of the mechanical properties of the steel which is more resistant to impact and scratches.

PHANTOM BASE - 12 mm

The Phantom BASE sink's bottoms are specifically engineered to be coupled with sinks made out of slabs. The perimetric trough makes for a simple and perfect installation. This version of Phantom BASE is meant for slabs of 12mm thickness.

PHANTOM BASE WITHOUT WELDING

The steel bottom Phantom BASE solves the problem of water draining of slab sinks, because the slope built into the moulded bottom ensures perfect draining. The radius and sloped profile of Phantom BASE guarantee great practicality and hygiene in everyday cleaning.

High thickness

1mm thick steel. A significant thickness, which guarantees the maximum sturdiness and durability.

Small radius

Bowls with squared shapes with a modern design and an increased capacity, for a minimal aesthetics connected with an extreme practicality.

Perimetral overflow

The overflow is always a security on the Foster sinks that prevents the overflow of water in case of oversights. The perimeter drain solution improves aesthetics thanks to its square and essential shape.

TECHNICAL DATA

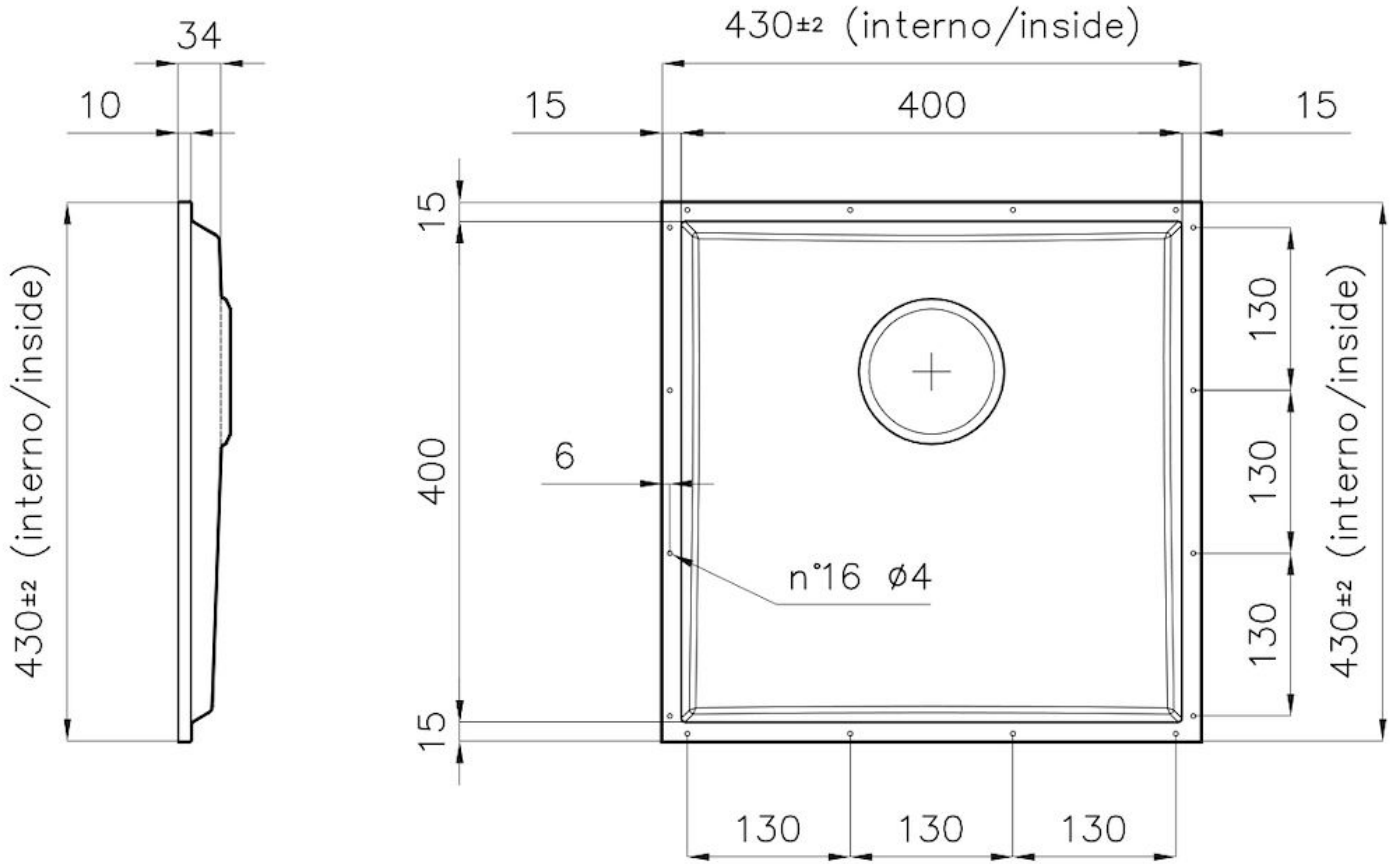





DETTAGLIO PER TROPPO PIENO / OVERFLOW DETAILS

GALLERY

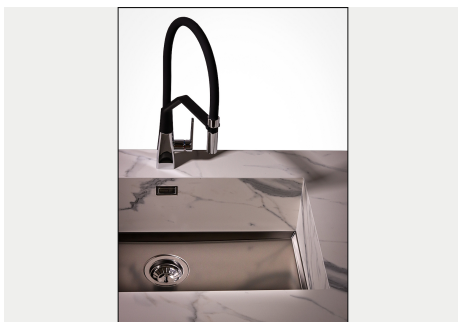

OPTIONAL ACCESSORIES



Cestello inox
8612 000



HPDE Chopping board
8657 001



Stainless steel plate rack
8100 201



White basket
8612 100



White bowl
8153 100

RECOMMENDED PAIRINGS



Mixer Tap FL
8521 000



Mixer Tap Omega
8497 000



Mixer Tap Omega Copper
8497 400



Mixer Tap Omega Plus
8497 020

OPTIONAL AUTOMATIC WASTE FITTINGS



Automatic waste fitting PM
8407 113